

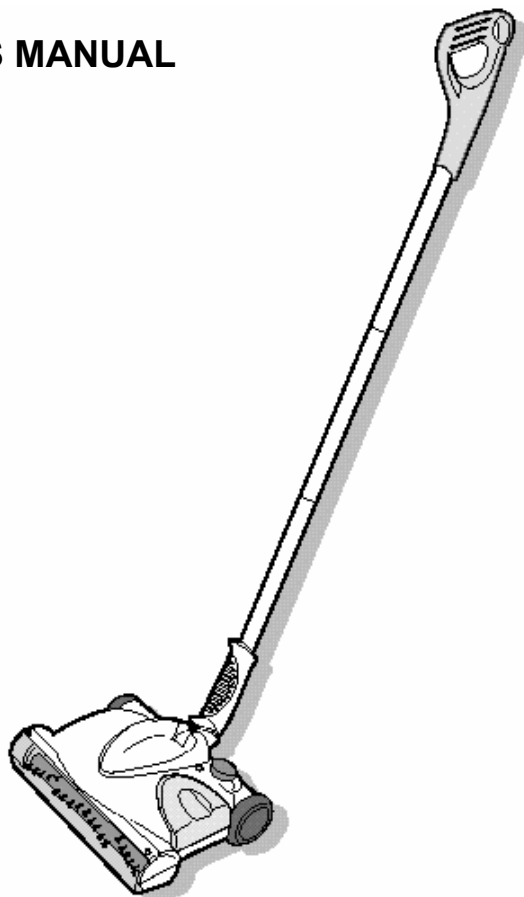

OWNER'S MANUAL

Model UV610
7.2 Volt DC



For information or assistance:

USA: **EURO-PRO** Corporation
178 West Service Rd.
Champlain, NY 12919
Tel: 1 866 98SHARK (1 866 987-4275)

Canada: **EURO-PRO** Corporation
4400 Bois Franc
St. Laurent, QC H4S 1A7
Tel: 1 866 98SHARK (1 866 987-4275)

www.sharkvac.com

EURO-PRO X

IMPORTANT SAFEGUARDS

When using an electrical appliance, basic safety precautions should always be observed, including the following

READ ALL INSTRUCTIONS BEFORE USING YOUR CORDLESS SWEEPER.

WARNING: To reduce the risk of fire, electrical shock, or injury:

1. Do not charge this unit outdoors.
2. Do not use outdoors or on wet surfaces.
3. Do not allow to be used as a toy. Close attention is necessary when used by or near children.
4. Use only as described in this manual. Use only manufacturer's recommended attachments.
5. Do not use with damaged cord or plug. Do not use cordless sweeper if it has been dropped, damaged, left outdoors, or dropped in water. Return it to **EURO-PRO** Corporation for examination, repair or adjustment.
6. Do not abuse the charger cord. Never carry the charger or base by the cord or yank to disconnect from an outlet; instead grasp the charger and pull to disconnect.
7. Keep charger cord away from heated surfaces.
8. This product includes rechargeable nickel cadmium batteries. Batteries must be recycled or disposed of properly. **Do not incinerate batteries or expose to high temperatures**, as they may explode.
9. Do not handle plug or appliance with wet hands.
10. Do not put any object into openings. Do not use with any opening blocked; keep free of dust, lint, hair and anything that may reduce air flow.
11. Keep hair, loose clothing, fingers, and all parts of body away from openings and moving parts.
12. Do not pick up anything that is burning or smoking, such as cigarettes, matches, or hot ashes.
13. Do not attempt to change accessories while unit is running.
14. Use extra care when cleaning on stairs.
15. Do not use to pick up flammable or combustible liquids such as gasoline or use in areas where they may be present.
16. Read and follow all label, operational and marking instructions.
17. Do not use charger with an extension cord. Plug charger directly into an electrical outlet. Use charger only in a standard (120V~, 60Hz) electrical outlet.
18. Keep end of rotating brush, hose, wands and other openings away from your face and body.
19. **Do not use the cordless sweeper without dust container in place.**
20. Store the cordless sweeper indoors. Store after use to prevent accidents.
21. Leaks from battery cells can occur under extreme conditions. If the liquid, which is 20-35% solution of potassium hydroxide, gets on the skin - wash immediately with soap and water or neutralize with a mild acid such as lemon juice or vinegar. If the liquid gets into the eyes, flush them immediately with clean water for a minimum of 10 minutes and seek medical attention.
22. Use only on dry, indoor surfaces.
23. Do not use for any purpose other than described in this user's guide.
24. Do not attempt to use the charger with any other product or attempt to charge this product with another charger. **Use only the charger model TechWorld AD-0920-UL supplied with this appliance.**
25. The battery is to be recycled or disposed of safely.
26. The appliance must be disconnected from the supply when removing the battery

SAVE THESE INSTRUCTIONS FOR HOUSEHOLD USE ONLY

Shark™

CORDLESS SWEEPER

Model UV610
7.2 Volt DC

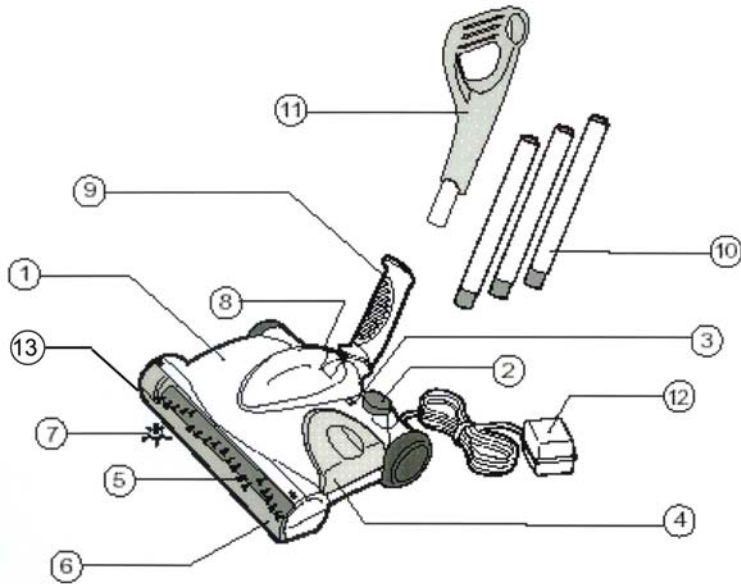

- | | |
|-----------------------------|--|
| 1. Sweeper Power Head | 8. Charging Jack |
| 2. On / Off Switch | 9. Lower Handle |
| 3. Charging Light Indicator | 10. Metal Extension Handles |
| 4. Dust Cup (Container) | 11. Upper Handle |
| 5. Rotating Brush | 12. Charging Adapter |
| 6. Transparent Brush Cover | (TechWorld AD-0920-UL
rated output DC 9V, 200mA.) |
| 7. Edging Tool | 13. Gear Box |

NOTE: Cordless Sweeper Model UV610 is shipped with the batteries uncharged. Charging of the unit for 16-20 hours prior to first use is required.

ASSEMBLING YOUR CORDLESS SWEEPER

Before you start:

Your Cordless Sweeper will require very little assembly. You should remove it from the carton and familiarize yourself with all the components listed per the exploded view drawing (pg.2) This will help you in the assembly and operation of your cordless sweeper.

1. Insert the Edging Tool into the "square" hole under the bottom of the sweeper power head. Gently but firmly push until the edging tool locks into place. (See fig. 1)

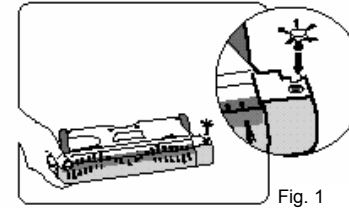

Fig. 1

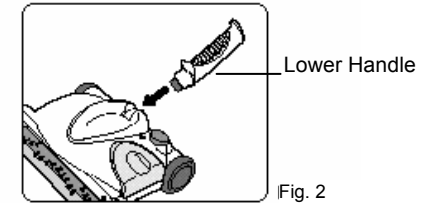

Fig. 2

2. Insert the lower handle - small end - into the sweeper power head. Push until firmly in place. (Fig. 2)
3. Assemble the metal extension handles by pushing the plastic insert into the mating metal tube. Push until only small portion of insert is visible or you cannot press any farther into the tubing. Push the handle assembly into the upper handle. (Fig. 3)
NOTE: One metal extension tube has a different plastic insert. This tube should be on the bottom of the handle.
Insert the handle assembly into the lower handle so that the "tab" on the plastic insert snaps into the open slot on the lower handle. (Fig. 3a)

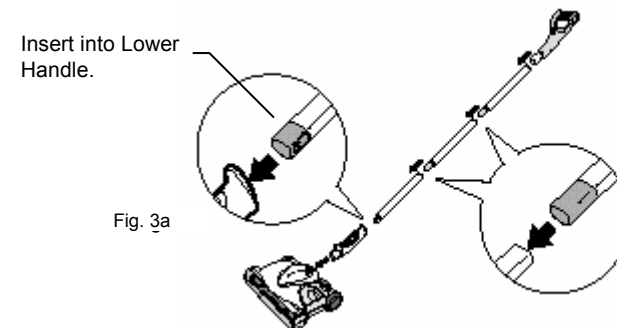

Fig. 3a

Fig. 3

4. Place the handle into the upward storage position.
5. Plug the charging adapter into the sweeper power head charging jack. Plug the charging adapter cord into a standard electrical outlet (120V~,60Hz.)

HOW TO OPERATE YOUR CORDLESS SWEEPER

1. Before using, please ensure that the cordless sweeper has been initially charged for 16-20 hours
Your cordless sweeper will only operate properly when the batteries are fully charged. When fully charged your sweeper will operate for 35-45 minutes - dependent upon the type of use (example - carpets or bare floors).
2. Push the On/Off switch to operate the unit. To turn off, press switch again.(Fig.4)
NOTE: Do not operate the sweeper without the dust container in place.

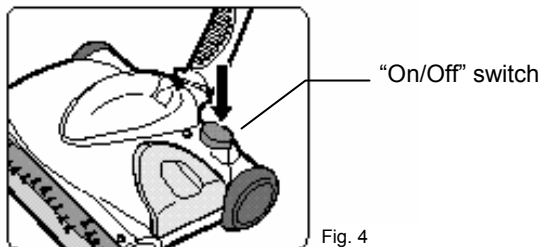

Fig. 4

CAUTION: Any electronic or electrical appliance should not be stored in or exposed to areas of high heat or humidity. Do not store your cordless sweeper close to stoves, radiators, furnaces or in a bathroom or bathing area.

3. To release the handle to a comfortable position, apply pressure to the top of the sweeper head with your foot while pulling back on the handle.(Fig. 5)



Fig. 5

CLEANING THE DUST CONTAINER

To achieve the best performance, empty the dust container after each use.

1. Pull the dust container straight out from the side. (Fig. 6)

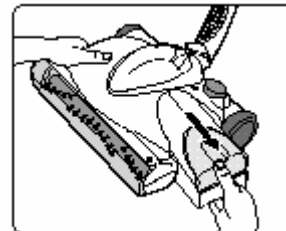

Fig. 6

2. Empty dust container contents. (Fig. 7) If desired- you may rinse with water to clean the dust container - but **dry thoroughly** before replacing on the sweeper.

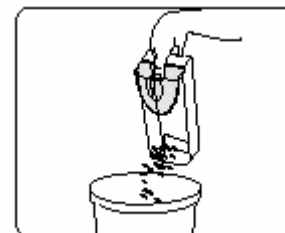

Fig. 7

3. Replace dust container on cordless sweeper.
4. Periodically remove the transparent brush cover on the front of the cordless sweeper and remove any build up of lint, hair or fiber on the rotating brush. To remove the cover - grip the cover from the bottom, pull out and upward until the cover unlocks from the side slots and tabs located on the top of the sweeper. (Fig. 8)

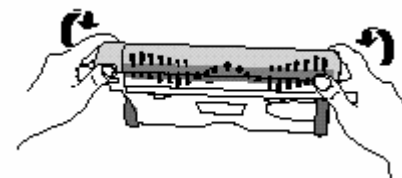

Fig. 8

CAUTION: Do not accidentally turn unit on while cleaning. Do not clean while unit is charging.

CHARGING THE CORDLESS SWEEPER

1. Connect the charger plug to the charging jack or hole on the back of the sweeper. Plug the the charging adapter into the wall outlet. (120V~,60Hz.) Use only TechWorld Charger AD-0920-UL, rated output DC 9V,200mA. (Fig. 9)
2. This cordless sweeper is powered by Ni-Cd batteries. Before first use, they must be charged for a minimum of 16 hours.
3. Once the batteries are fully charged, the cordless sweeper will run for approximately 35 to 45 minutes before recharging is required.
4. When recharging the unit, the "On/Off" switch must be in the "OFF" position.
5. To recharge, repeat step #1 above. Charging times will vary depending upon the amount of usage between charging cycles.
6. The charging light indicator on the top of the sweeper will illuminate to indicate that the sweeper is properly charging.

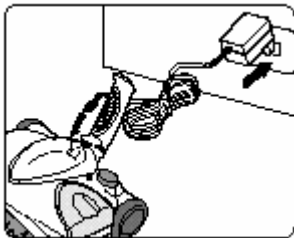

Fig. 9

NOTE: Peak performance may only be realized after the unit has been charged and discharged two (2) or three (3) times.

IMPORTANT: To maintain peak performance of your cordless sweeper, it is recommended that the unit be fully discharged, then completely re-charged at least once a month.

CAUTION

- Use only with the battery pack supplied with the unit.
- Do not attempt to remove the battery pack from the unit to charge it.
- Never attempt to throw the battery pack or unit into a fire or incinerate it.
- Do not attempt to remove or damage the battery casing.
- Battery must be recycled or disposed of properly at the end of it's service life.

Changing the Rotating Brush & Gear Box

WARNING: Use caution when changing the rotating brush and gear box so that the unit does not turn ON when pressing down on the sweeper power head.

1. Remove the extension tube handle from the sweeper power head.
2. Turn sweeper power head upside down being careful **Not** to accidentally turn the unit ON.
3. Remove the transparent brush cover. (Fig. 10) (Refer to page 5 for detailed instructions.)
4. Push in on the locking tab of the gear box and lift gear box to remove. (Fig. 11 & Fig. 12)
5. Lift the brush bar end cap up from the slot. (Fig. 13)
6. Pull the brush bar out from the bushing and slip off the belt to remove the brush bar. (Fig. 14)
7. Insert the new brush bar by first inserting the brush bar into the bushing on the end opposite the driver belt. (Fig. 14)
8. Slip the belt over the brush bar cap.
9. Insert the brush bar into the slot. (Fig. 13)
10. Insert the gear box tabs into the tab slots and push down until it clicks into place.

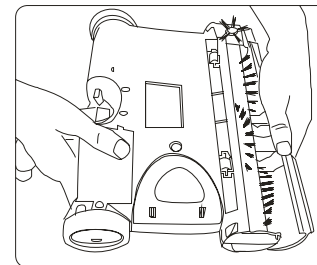

Fig. 10

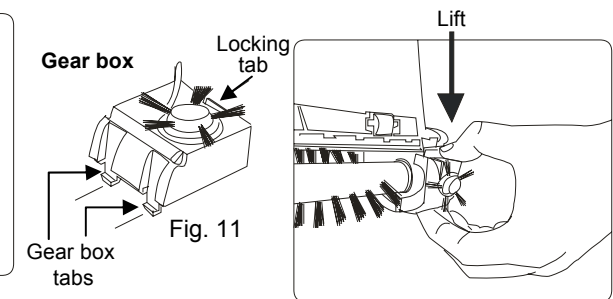

Fig. 11

Fig. 12

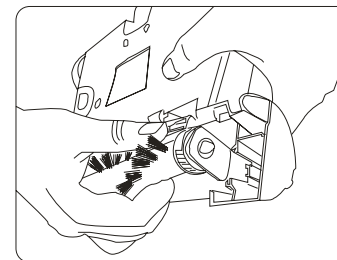

Fig. 13

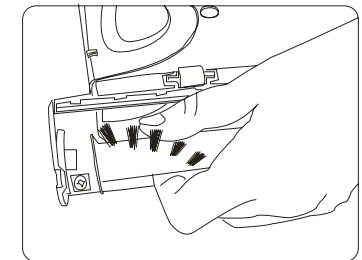

Fig. 14

Battery Removal & Disposal



Care and Maintenance

To improve the performance and life of your unit, we recommend you do the following:

1. Once a month clean the unit with a dry cloth, including the chamber which



ONE (1) YEAR LIMITED WARRANTY

EURO-PRO CORPORATION warrants this product to be free from defects in material and workmanship for a period of one (1) year from the date of the original purchase, when utilized for normal household use, subject to the following conditions, exclusions and exceptions.

If your appliance fails to operate properly while in use under normal household conditions within the warranty period, return the complete appliance and accessories, freight prepaid to:

In US: **EURO-PRO** Corporation, 178 West Service Rd., Champlain, N.Y. 12919
In Canada: EURO-PRO Corporation, 4400 Bois Franc, St. Laurent, QC, H4S 1A7

If the appliance is found by **EURO-PRO** to be defective in material or workmanship, **EURO-PRO** will repair or replace it free of charge. Proof of purchase date and \$ 11.95 to cover the cost of return shipping and handling must be included. *

Non-durable parts including, without limitation, dust cups, filters and brushes which normally require replacement are specifically excluded from warranty.

The liability of **EURO-PRO** Corporation is limited solely to the cost of the repair or replacement of the unit at our option. This warranty does not cover normal wear of parts and does not apply to any unit that has been tampered with or used for commercial purposes. This limited warranty does not cover damage caused by misuse, abuse, negligent handling or damage due to faulty packaging or mishandling in transit. This warranty does not cover damage or defects caused by or resulting from damages from shipping or repairs, service or alterations to the product or any of its parts, which have been performed by a repair person not authorized by **EURO-PRO**.

This warranty is extended to the original purchaser of the unit and excludes all other legal and/or conventional warranties. The responsibility of **EURO-PRO** Corporation if any, is limited to the specific obligations expressly assumed by it under the terms of the limited warranty. **In no event** is **EURO-PRO** Corporation liable for incidental or consequential damages of any nature whatsoever. Some states do not permit the exclusion or limitation of incidental or consequential damages, so the above may not apply to you.

This warranty gives you specific legal rights, and you may also have other rights which vary from province to province.

*